



SunCap

Installation Instructions

For: Jeep Wrangler JK (2 Door)
2007 – 2010

Part Number: 41522

For Use With or Without Door Surrounds



IMPORTANT NOTE: For a vehicle equipped with a soft top. If you need a Windshield Channel Kit order 51243-01.

DO NOT INSTALL THIS PRODUCT ON ANY VEHICLE OTHER THAN THOSE LISTED ABOVE.

This product is only designed for the vehicles listed above. Failure to install this product on the proper vehicle could cause injury to the vehicle occupants and damage to the product.

Installation Tips

Before you begin installing this assembly, read all instructions thoroughly.

For a smooth fit:

For ease in installation, the product should be installed at temperatures above 72° F. Below this temperature, the fabric may contract an inch or more, making it difficult to fit to the vehicle. It is normal for fabric to contract and wrinkle when stored in the shipping carton. Within a few days after the installation, the fabric will relax and the wrinkles will disappear.



WARNING

This product is designed to enhance the appearance of the vehicle. Do not rely in any way on the components of this product to contain occupants within the vehicle, or to protect against injury or death in the event of an accident. Never operate vehicle in excess of manufacturer's specifications.

WEAR SEAT BELTS AT ALL TIMES

Read and follow, precisely, all installation instructions provided when installing this product. Failure to do so could place occupants of the vehicle in a potentially dangerous situation. After installing or reinstalling, check to make sure it has been properly installed.

Table of Contents

PARTS LIST	PAGE 2
TOOLS NEEDED	PAGE 2
INSTALLATION	PAGE 2
WARRANTY	PAGE 4



CAUTION

Safety glasses should be worn at all times while installing this product.

Parts List		
SunCap		Qty - 1
Long Tension Strap, Part Number 424.14		Qty - 2
Short Tension Strap, Part Number 460.37		Qty - 2

Step One

SNAP SUNCAP TO HEADER

Slide the pocket sewn along the front of the SunCap over the edge of the header and snap it to the snaps.

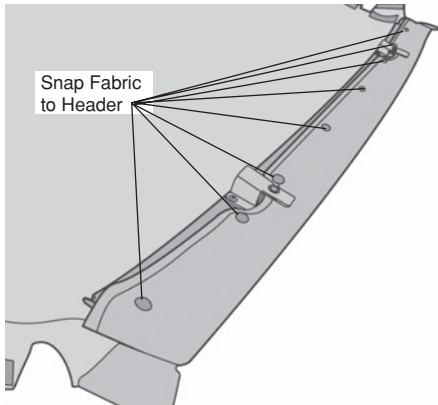

Step Two

SECURE HEADER TO WINDSHIELD

Center the SunCap on the vehicle. Place the tabs on the Header Knob Bases above the footman loops in the windshield frame. Place a Header Knob Plate under a footman loop. Install a Header Knob through the plate and footman loop and thread it into the Header Knob Base. Repeat this with both Header Knob Bases.

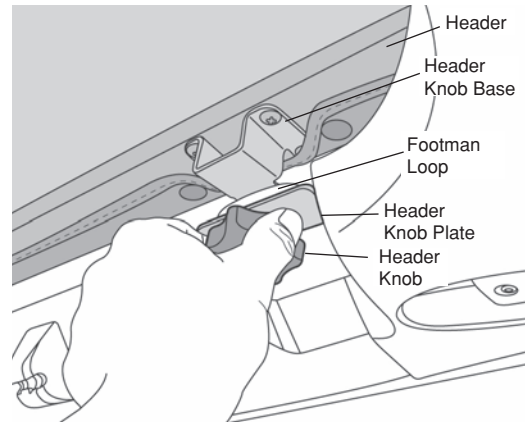

Step Three

INSTALL SHORT TENSION STRAPS

Drape the SunCap over the speaker pod. Thread a Short Tension Strap through the two buckles sewn to the rear of the SunCap. Pull the straps under the pod and hook each strap into the opening as shown. Pull the end of each strap to tighten securely.

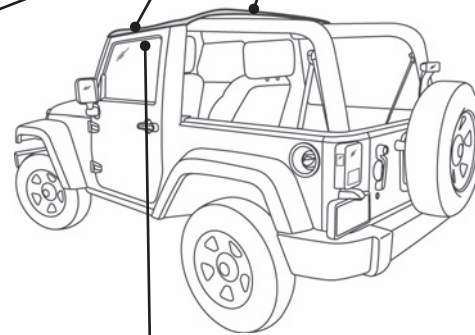
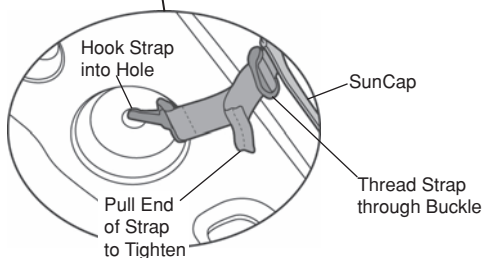
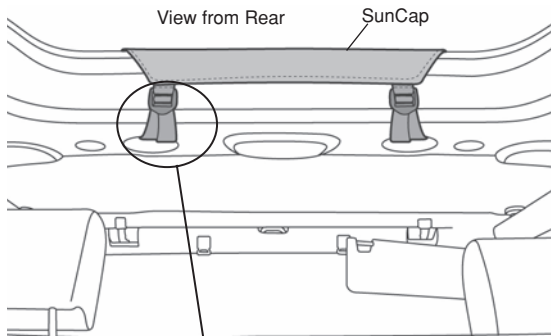

Step Four

SECURE FLAPS

Wrap the flap above the door opening around the horizontal sport bar and fasten the hook and loop. Repeat on both sides.

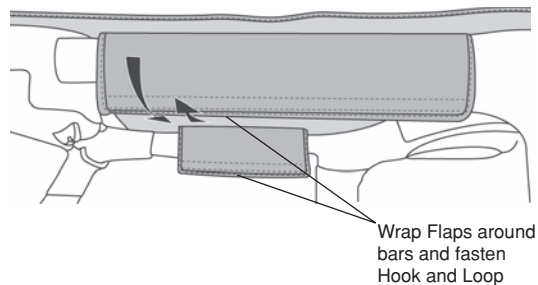

Step Five

INSTALL LONG TENSION STRAPS

Thread a Long Tension Strap through the buckle on the side of the SunCap. Pull the strap under the pod and hook it into the same hole as the right rear buckle strap. Repeat on the other side of the vehicle.

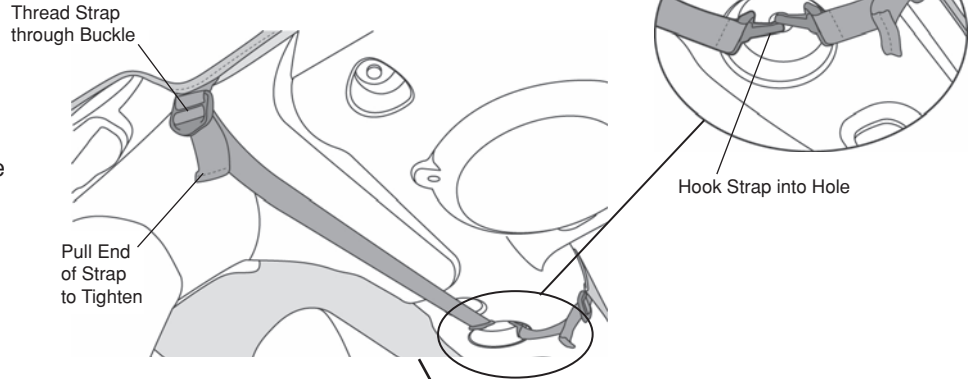

Step Six

SECURE REAR CORNER STRAPS

Locate the buckle straps sewn to the rear corners of the SunCap. Wrap the strap under the SunCap and around the sport bars. Thread the end of the strap through the buckle and pull it tight. Repeat on the other side.

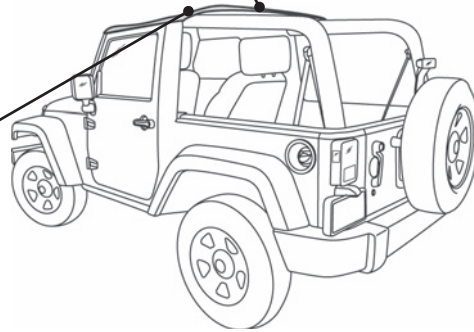
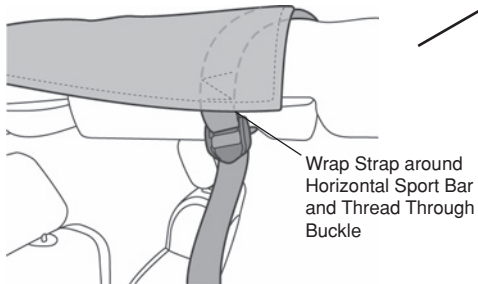

Care and Maintenance of your New SunCap

Your SunCap is made of the finest materials available. To keep it looking new and for the maximum possible wear, it will need periodic cleaning and maintenance.

Washing: The fabric should be washed often using soap, warm water and a soft bristle brush. Rinse with clear water to remove all traces of soap.

Water: Seeping through at the seams may be stopped by applying 3-M Scotchgard® on the inside of the seams. Rips in the fabric may be repaired with Bondex® iron on patches. Iron the patches to the Inside of the top, carefully following the Bondex® instructions.

LIMITED WARRANTY

We warrant our product to be free from defects in material and workmanship, for terms specified below, provided there has been normal use and proper maintenance. This warranty applies to the original purchaser only. All remedies under this warranty are limited to the repair or replacement of any item or items found by the factory to be defective within the time period specified.

If you have a warranty claim, first you must call our factory at the number below for instructions. You must retain proof of purchase and submit a copy with any items returned for warranty work. Upon completion of warranty work, if any, we will return the repaired or replaced item or items to you freight prepaid. Damage to our products caused by accidents, fire, vandalism, negligence, misinstallation, misuse, Acts of God, or by defective parts not manufactured by us, is not covered under this warranty.

THE WARRANTY TIME PERIOD IS AS FOLLOWS: ALL "GOODS" MANUFACTURED BY OUR COMPANY: ONE YEAR FROM DATE OF PURCHASE.

ANY IMPLIED WARRANTIES OF MERCHANTABILITY AND/OR FITNESS FOR A PARTICULAR PURPOSE CREATED HEREBY ARE LIMITED IN DURATION TO THE SAME DURATION AND SCOPE AS THE EXPRESS WRITTEN WARRANTY. OUR COMPANY SHALL NOT BE LIABLE FOR ANY INCIDENTAL OR CONSEQUENTIAL DAMAGE.

Some states do not allow limitations on how long an implied warranty lasts, or the exclusion or limitation of incidental or consequential damages, so the above limitations or exclusions may not apply to you.

This warranty gives you specific legal rights, and you may also have other rights which vary from state to state.

For further information, please contact:

Customer Service
877-638-9509

All or a portion of this product may have been made in China.